



Phocos Any-Grid™ series

Any-Grid™ use with Lithium battery models:
Pylontech US2000, US3000, Phantom-S,
Force L1 and Force L2

Applicable for Any-Grid™ PSW-H-5kW-230/48V

[Recommended battery settings guide](#)

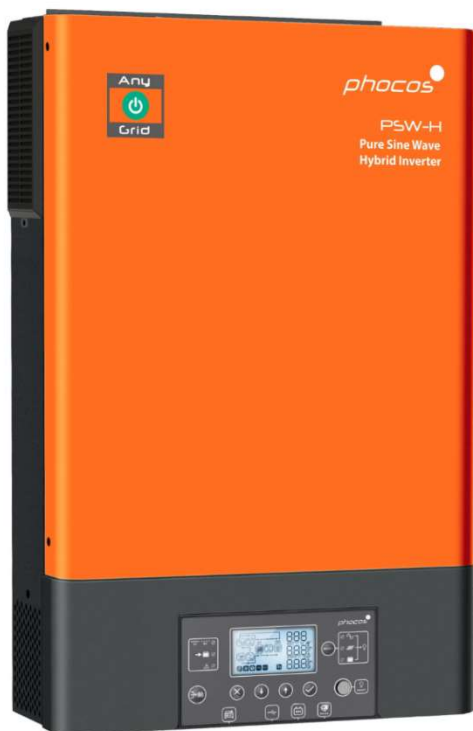

1.0 Introduction

This guide outlines the recommended settings and establishing communication for operation of one or more Any-Grid™ PSW-H-5kW-230/48V hybrid inverter chargers with Pylontech US2000, US3000, Phantom-S, Force L1 and Force L2 battery racks, referred to in this guide as “battery racks”.

The Any-Grid must be installed according to the Any-Grid “User and Installation Manual” included with every Any-Grid unit and available online at www.phocos.com. The battery terminals of the Any-Grid must be connected to the battery racks according to the Pylontech installation manual at the appropriate step mentioned in the chapter “**5.0 Battery Settings and Communication Cable Installation**” of this manual.

WARNING: Be sure to read and respect the warnings in the installation manuals of the Any-Grid, the battery racks and any other connected equipment. The installation must be conducted by a trained professional.

2.0 Requirements

The following is required to proceed with this guide:

- Any-Grid PSW-H-5KW-230/48V
- Battery communication cable: PSW-H-BAT-CABLE-PYLON-2, or alternatively PSW-H-BAT-CABLE-PYLON
This cable can be purchased separately from your Phocos dealer.

If it is not possible to obtain the cable from your dealer, the PSW-H-BAT-CABLE-PYLON is made of two male RJ45 plugs with **only** the following pins connected:

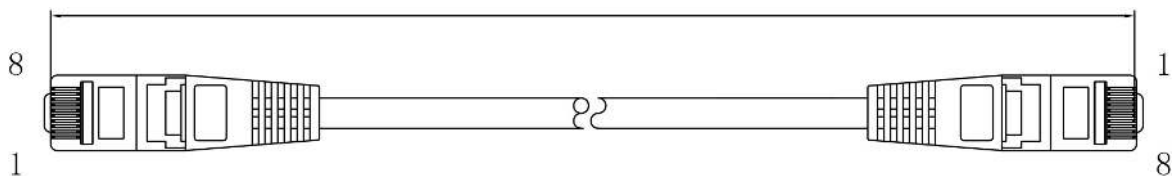

- Pin 3 ↔ Pin 1
- Pin 5 ↔ Pin 2

This way 4 pins (number 1, 2, 3 and 5) are connected on each side of the cable. It is not relevant which way the cable is oriented between the battery and PSW-H unit.

WARNING: Do not use the inverter cable included with your Pylontech batteries. Wiring your own cable according to the pinout above must be done at your own risk. Any damage to the PSW-H or battery due to incorrect wiring or use of an incorrect cable is not covered by any warranty.

- Pylontech battery rack(s)

3.0 System Overview

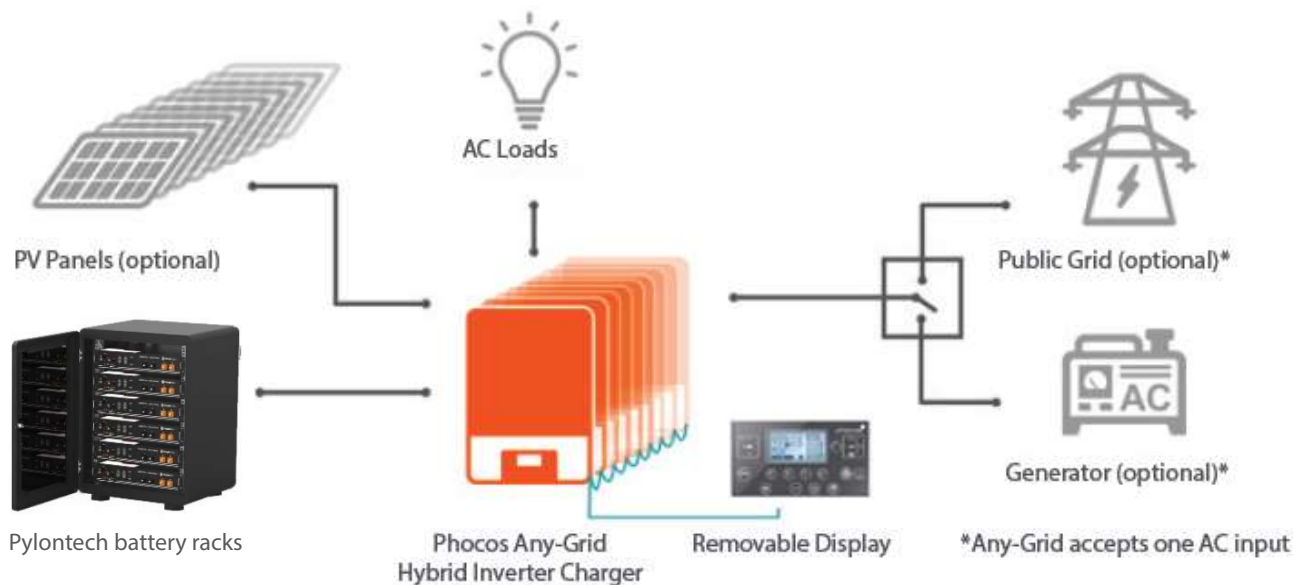

4.0 Battery Sizing

To maintain the full battery warranty, each battery rack should be sized not to exceed 25 Adc (37 Adc for the US3000, Force L1 and Force L2) continuous current and 100 Adc peak (105 Adc for the Force L1/L2). It is thus necessary to use at least 5 battery racks in parallel (4 for the US3000, Force L1/L2) to deliver both sufficient continuous current and peak current for a single PSW-H-5KW-230/48V at full power. When using multiple Any-Grid units, be sure to have at least 5 battery racks (4 for the US3000, Force L1/L2) per Any-Grid to sustain the required currents. Using less batteries per inverter may void your Pylontech battery warranty.

The batteries must be wired in parallel to form a single large battery bank when using multiple Any-Grids. All Any-Grids must be connected to a single battery array made up of a maximum of two clusters / groups of battery racks. The maximum number of battery racks per group is defined in the battery manual.

5.0 Battery Settings and Communication Cable Installation

CAUTION: Before connecting the battery racks to the Any-Grid(s), please follow the installation instructions in this chapter step by step. The battery, AC input source, AC output loads and PV input must remain disconnected until instructed otherwise.

The battery settings in this chapter are recommendations only. They are intended to keep the batteries within their operational limits (maximum voltage, maximum current, etc). These settings can be adjusted to optimize the performance of your particular system, but must be kept within the limits of the battery specifications.

1. Purchase the PSW-H-BAT-CABLE-PYLON-2 or PSW-H-BAT-CABLE-PYLON from a Phocos dealer. This cable is designed specifically for connecting the Any-Grid PSW-H to Pylontech battery racks.
2. Ensure the battery racks are turned off.

3.

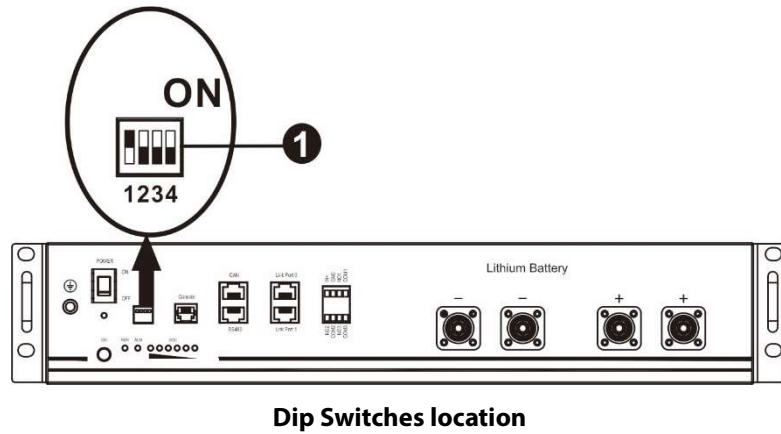

Locate the four Dip switches as shown above at position ❶ (position may vary on different battery rack models). Each switch can be set ON in the top position or OFF in the bottom position. Set the Dip switches as follows, depending on the number of battery clusters / groups:

Dip 1	Dip 2	Dip 3	Dip 4	Group address
ON	OFF	OFF	OFF	Single group only. The master battery rack must have this setting. Slave battery racks should have all Dip switches set to OFF.
RS-485 baud rate = 9600	ON	OFF	OFF	Two-group configuration. The master battery rack in the first group must have this setting. Slave battery racks should have all Dip switches set to OFF.
	OFF	ON	OFF	Two-group configuration. The master battery rack in the second group must have this setting. Slave battery racks should have all Dip switches set to OFF.

- Ensure the battery racks are still turned off. Connect the Any-Grid(s) to the battery power (positive and negative) terminals with the correct polarity.
- If you are using the PSW-H-BAT-CABLE-PYLON-2 cable, it is marked with a "PYLON" label on one of the two sides:



Connect this side to the master battery rack's "RS485" port and the other side into the Any-Grid display panel's "BMS" port

If instead you are using the PSW-H-BAT-CABLE-PYLON, it is not labelled. For this cable it does not matter which orientation you choose, as it functions in both orientations:



For systems with multiple Any-Grids, this connection (marked green) can be made with any of the inverters, but only a single unit. Remember, all Any-Grids in a synchronised system must be connected to a single battery bank as shown here for a system with 4 Any-Grids in parallel:

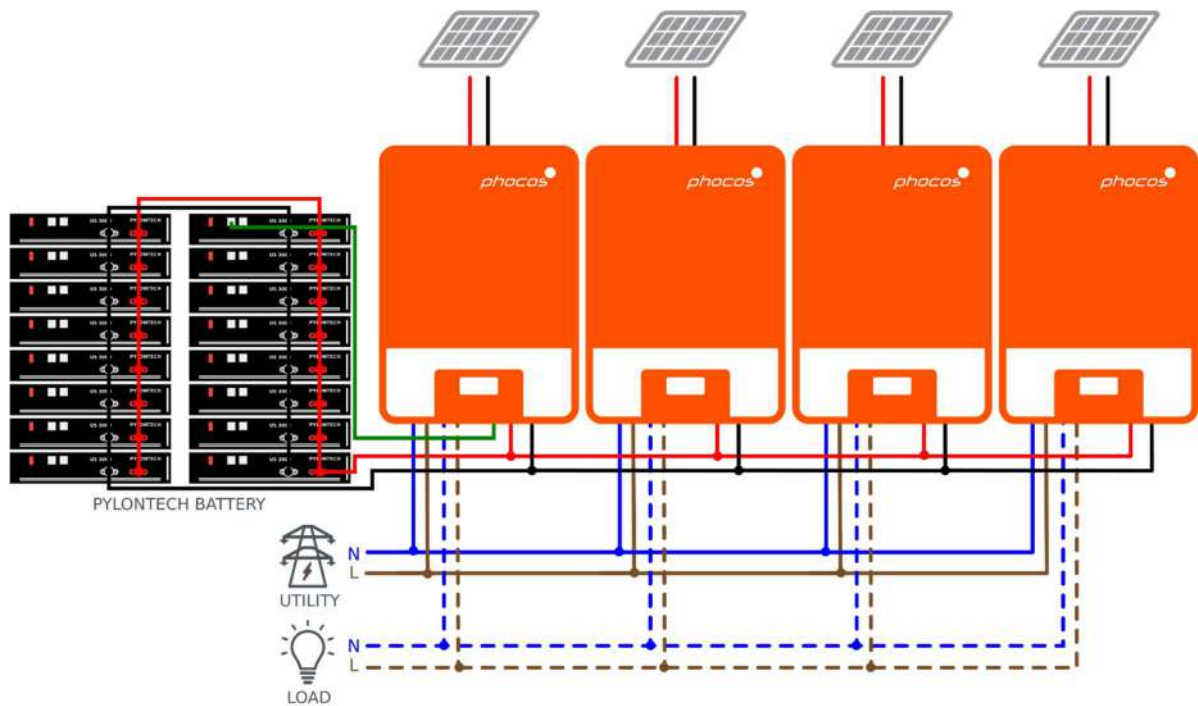

6. Ensure the battery racks are wired as outlined in the Pylontech battery manual. Turn on each of the battery racks with the power button and ensure the LED near the power button is green for all battery racks:



7. To supply the Any-Grid(s) with power, press the red START / SW on the master battery rack for more than 3 seconds.
8. Ensure the "ON/OFF" load power button of the Any-Grid(s) is in the ON position (depressed), but no loads are connected:

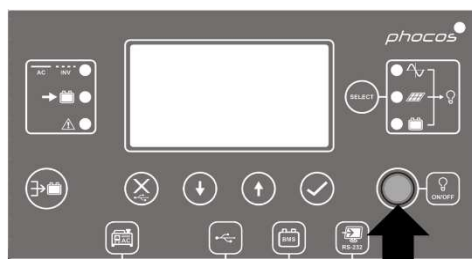

The Any-grid(s) should now be running, the display(s) on.

9. Apply the following settings on the Any-Grid to which the Pylontech battery is connected. These settings refer to the Any-Grid manual, chapter **Operation** → **Device Operation Settings** → **Settings menus**.

Start by setting changing the battery type to "User defined" in order to be able to change the remaining values:

- *Battery type*
Menu 05: User defined





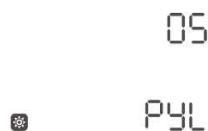

Now continue with these settings:

- *Maximum total battery charging current*
Menu 02: 80A
Note: this value will be over-written by the Pylontech battery with the next equal or lower current representing 0.5C of the nominal battery capacity. For example, if three 25 Ah batteries are used, 0.5C is 37.5A, so the next-lower value of 30A will be used by the Any-Grid.
- *Voltage set-point to switch from Off-Grid mode to Grid mode when "SBU priority" or "Solar / PV first" is selected in settings menu 01*
Menu 12: 48 Vdc or higher
- *Voltage set-point to switch from Grid mode to Off-Grid mode when selecting "SBU priority" or "Solar / PV first" in settings menu 01*
Menu 13: 52 Vdc or lower
- *Boost battery charging voltage*
Menu 26: 53.0 Vdc
Note: this value will be over-written by the Pylontech battery.
- *Floating battery charging voltage*
Menu 27: 52.0 Vdc
Note: this value will be over-written by the Pylontech battery.
- *Low voltage disconnect*
Menu 29: 47.0 Vdc
Note: this value will be over-written by the Pylontech battery.
- *Boost battery charging duration*
Menu 32: 60 min
- *Battery equalization*
Menu 33: Disabled
- *Maximum discharging current*
Menu 41: Disabled
- **Note: This setting must be set last, as some other settings mentioned here may not be modifiable once the battery type is set to "Pylontech battery". If you wish to modify them later, temporarily set the battery type to "User defined", change the settings as necessary, and then set the battery type back to "Pylontech battery".**

Battery type
Menu 05: Pylontech battery



10. Once the settings have been applied, exit the settings menu by pressing  to return to the main view.
11. Check that the battery icon  outline is flashing permanently to indicate the communication connection between the Any-Grid(s) and battery racks is successfully established. This may take a few minutes.
12. If no warnings or errors are shown, proceed to check the successful communication connection:

Press the  or  button on the Any-Grid to which the battery racks are connected to cycle through the screen views. The number of battery racks and battery groups are shown in the information screen view before the “Main unit firmware version (U1)” as shown below:

Information	Screen View Example
Battery rack and battery group quantity	Battery parallel rack quantity = 8, battery group quantity = 2 

If errors or warnings are shown, consult the Any-Grid manual for details. Warning codes 60, 61, 69 and 70 are specific to Lithium battery communication functionality.

Note: The settings menus 02, 26, 27 and 29 outlined in step 9 are over-written once communication with the battery is established. This is to ensure the maximum life expectancy of the battery and to maintain battery warranty.

13. Activate the circuit breakers or insert the fuses to energize the various inputs and outputs on the Any-Grid in the following order (skip any that are not connected):
 - a) AC input
 - b) PV input
 - c) AC output

14. If you are using more than one Any-Grid, this procedure ensures that unit to which the Pylontech battery is connected, will communicate with the Pylontech battery BMS. Automatically, the battery type of all other connected Any-Grid units will be set to “User-defined”, this is normal.

The commissioning and programming of the battery-related settings of the Any-Grid is now complete.

The content of this document is subject to change without notice.

Copyright © 2020 Phocos AG, all rights reserved.

Version: 20200504

Phocos AG
 Magirus-Deutz-Str. 12
 89077 Ulm, Germany

Phone +49 731 9380688-0
 Fax +49 731 9380688-50

www.phocos.com
info@phocos.com