

Installation and Operating Instructions

Electrolyte Circulation System

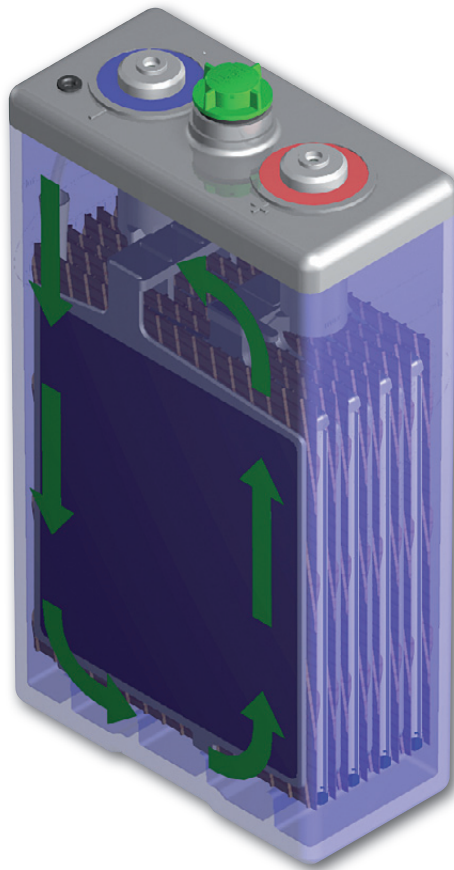

Installation and Operating Instructions
Electrolyte Circulation System

Type, Design, Print: Koerdt Promo4you GmbH, 59929 Brilon

© 2013 HOPPECKE Batterien GmbH & Co. KG
P.O. Box 1140
D-59914 Brilon

All rights reserved, even for patent and utility patent applications.

The distribution and duplication of this document and the use and disclosure of its contents are prohibited unless written permission is granted by HOPPECKE Batterien GmbH & Co. KG. Noncompliance will result in a claim for damages.

Table of contents

Preface 4

Safety precautions 5

Required parts and tools..... 6

Parts of delivery 7

System overview 8

Installation..... 10

 Step 1: Equip battery cells with air tubes 10

 Step 2: Connect all air tubes 12

 Step 3: Mount the pump- and control unit 13

 Step 4: Connect air tube to the pump and control unit 14

 Step 5: Install current sensor 15

 Step 6: Connect power supply 17

Operation 21

Connection terminals..... 22

Error states 22

Maintenance 22

Technical Data 23

Annex A: References 24

Preface

The HOPPECKE Electrolyte Circulation System pumps ambient air to the bottom of each battery cell. Emerging air bubbles rise through the electrolyte, ensuring a homogeneous electrolyte density distribution in each battery cell.

The HOPPECKE Electrolyte Circulation System provides several important benefits:

- *Economic recharge* - increased charging efficiency, reduced recharge time and cost reduction
- *Environment-friendly* - reduced runtime of additional (Diesel) generators and cost savings
- *Extended battery service life* - no acid stratification
- *Minimum maintenance costs* - maintenance free pump system (automatically controlled)
- *Reduced battery service costs* - reduced water loss for longer refill intervals

The HOPPECKE Electrolyte Circulation System is applicable for HOPPECKE OPzS solar.power batteries (6 OPzS solar.power 910 Ah to 26 OPzS solar.power 4700 Ah) only. Figure 1 shows the general architecture of the system.

Note: The Electrolyte Circulation System cannot be used with a recombination system (HOPPECKE AquaGen® premium.top) simultaneously. Any recombination system plugs need to be replaced by the HOPPECKE Labyrinth plugs (refer also to /3/).

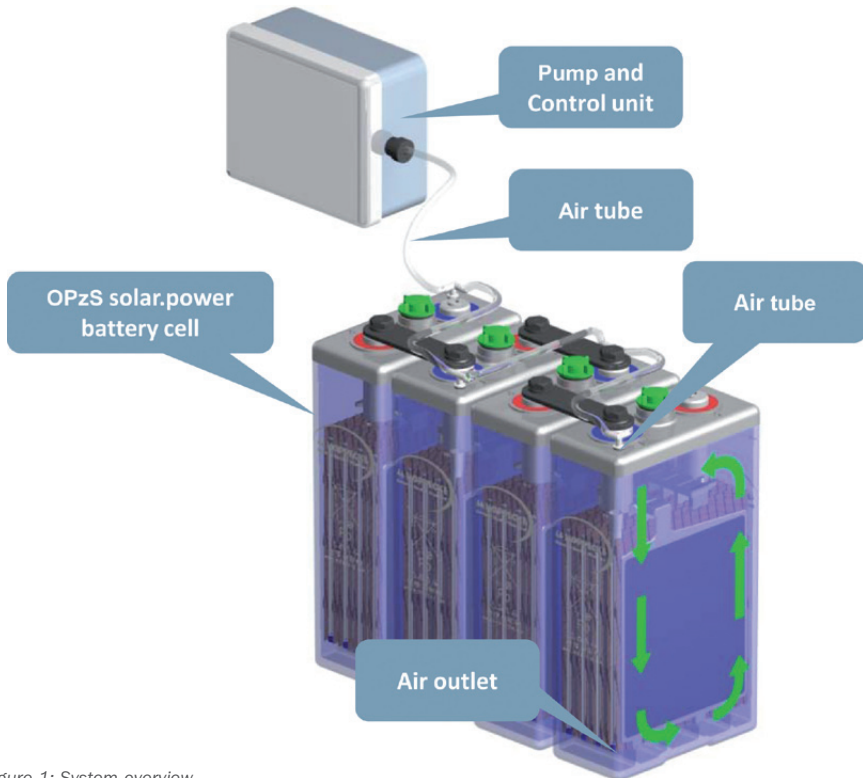

Figure 1: System overview

Safety precautions



Danger!

Incorrect use of the product described here can lead to personal and material damage. HOPPECKE is not responsible or liable for direct or indirect personal and material damages which occur as a result of handling the products described here.



Risk of explosion or blast, splashing of hot or molten substances.
Explosion and fire hazard, avoid short circuits!
Avoid electrostatic charge and discharge / sparks.
Failure to observe this hazard notice can lead to severe or fatal injury.



Electrical voltages hazardous to health may cause fatal injury.
Metal parts of the battery are always alive, therefore do not place items or tools on the battery.
Failure to observe this hazard notice can lead to severe or fatal injury.



Do not smoke!
Do not use any naked flame or other sources of ignition.
Risk of explosion and fire!



Danger!

Electrolyte is highly corrosive. Leaking electrolyte is harmful to the eyes and skin.

Note: Potential hazards:

Diluted acid may cause severe acid burns.

First-aid measures:

General instructions:

Remove soiled, wetted clothing immediately

After contact:

Rinse with a lot of water immediately after contact to skin.

After inhalation of acid mist:

Inhale fresh air¹⁾

After contact with eyes:

Rinse under running water for several minutes¹⁾

After swallowing:

Drink a lot of water immediately and swallow activated carbon¹⁾

1) Seek the advice of a medical doctor immediately.



Danger!

Work on batteries, especially installation and maintenance should be performed by trained HOPPECKE specialists (or by personnel authorized by HOPPECKE) only; personnel must be familiar with battery handling and the required precautionary measures.
Unauthorized persons must keep away from the batteries.

Observe the following regulations (IEEE standards valid for USA only):

- ZVEI publication „Instructions for the safe handling of electrolyte for lead-acid accumulators.“
- ZVEI publication „Safety data sheet on accumulator acid (diluted sulfuric acid).“
- VDE 0510 Part 2: 2001-12, in accordance with EN 50272-2:2001: „Safety requirements for secondary batteries and battery installations - Part 2: Stationary batteries“.
- IEEE Standard 450-2002: „Recommended Practice for Maintenance, Testing and Replacement of Vented Lead Acid Batteries for Stationary Application.“
- IEEE Standard 1375-1998: „Guide for Protection of Stationary Battery Systems“

Further on observe the following safety rules:

1. Ensure that all electrical loads are switched off (separators, fuses, switches). The electrolyte circulation pump system needs to be switched off (via the two corresponding fuses) as well. This must be carried out by qualified personnel.
2. Remove all wrist watches, rings, chains, jewelry and other metal objects before working with batteries.

3. Use insulated tools only.
4. Wear insulating rubber gloves and rubber shoes.
5. Never place tools or metal components on top of the batteries.
6. Make sure that the battery or batteries are not mistakenly grounded. If the system is grounded, terminate the connection. Touching a grounded battery by mistake can result in severe electric shock. The risk caused by an incorrect connection can be significantly reduced by terminating the ground connection.
7. Before establishing connections, make sure to check the correct polarity – better one too many times than one too few.
8. Filled lead-acid batteries contain highly explosive gas (hydrogen/ air mixture). Never smoke, handle open flames or create sparks near the batteries. Always avoid electrostatic discharge; wear cotton clothing and ground yourself if necessary.
9. Wear the appropriate safety clothing and equipment.



To avoid electrostatic charging, all textiles, protective shoes and gloves worn while working with batteries must have a surface resistance of $<10^8$ Ohm and an insulation resistance of $\geq 10^5$ Ohm (refer EN 50272-2 and DIN EN ISO 20345:2011 Personal protective equipment – Safety footwear).

Refer also to the HOPPECKE manual “Installation, commissioning and operating instructions for vented stationary lead-acid batteries” (refer to /1/).

For questions and comments refer to:
www.hoppecke.com
info@hoppecke.com

Required parts and tools







The following tools are required for installation of the Electrolyte Circulation System:

1. Power drill
2. Cutter knife or scissors
3. Screwdriver
4. Crimping pliers

Depending on the installation site various anchor bolts are required for wall mounting of the pump- and control unit as well as for the DIN cap rail (required for the fuse holders).

Depending on the operating conditions of the system an additional installation box is required for the fuse holders.

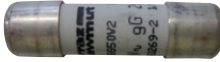
Parts of delivery

1 x Housing with DC-pump- and control unit	
1 x Sensor unit for current detection	
2 x Battery terminal connection bolts	
1 x DIN cap rail (35 mm) for installation of fuse holders	
2 x Fuse holders for DIN cap rail mounting	
2 x Fuses (2A)	
Air Tubes with connectors	
1 x Back-pressure valve	
Connection Cables for power supply (1.5 mm ² and 6 mm ²)	
2x Cable lugs for 6 mm ² power supply cable	
2 x Wire termination (6 mm ²) for power supply cables	
4 x Wire strips	

System overview

The pump- and control unit comes with a plastic housing for wall mounting. The air outlet of this unit is connected to the air tubing (refer to Figure 2). For switching the air pump during battery charge periods an inductive current sensor is connected to the pump- and control unit. The power supply for the pump- and control unit comes from the battery (24V / 48V). Refer also to Figure 3 and Figure 4.

Note: For 48V battery systems with larger cells (18 OPzS solar.power 3250 up to 26 OPzS solar.power 4700) two electrolyte circulation pumps are required (refer to Figure 5).



Figure 2: Pump and control unit

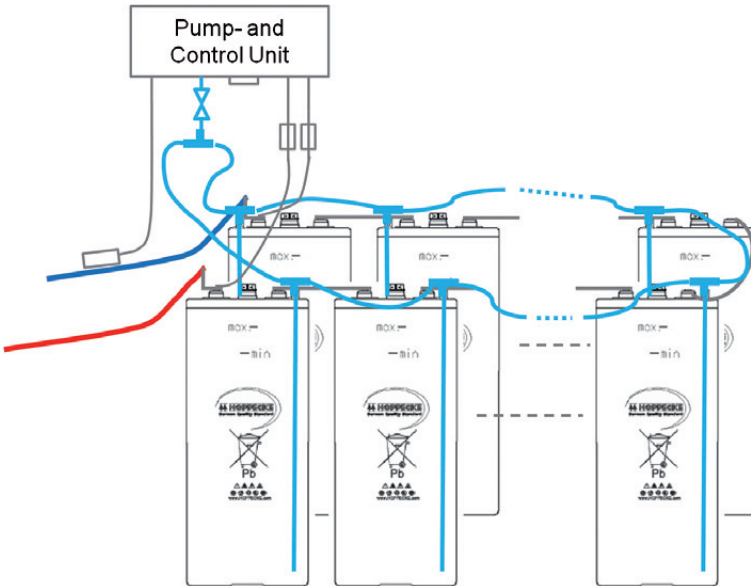

Figure 3: Schematic diagram

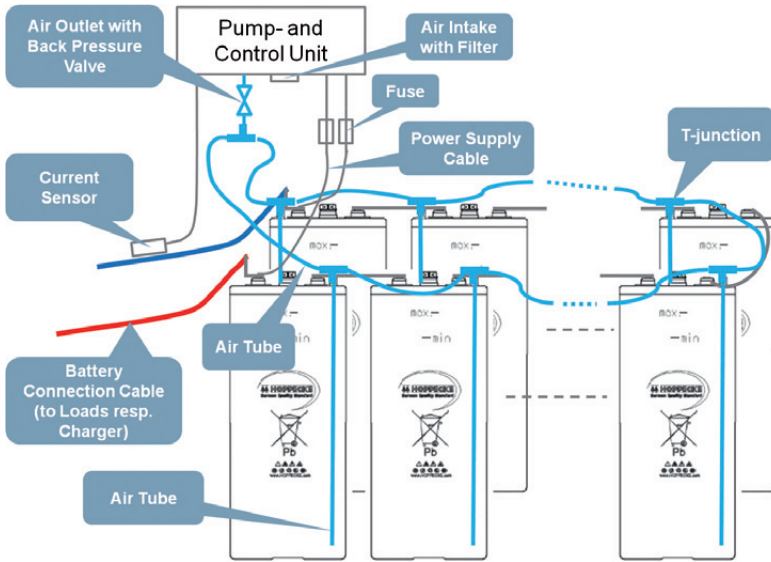

Figure 4: System overview - Components

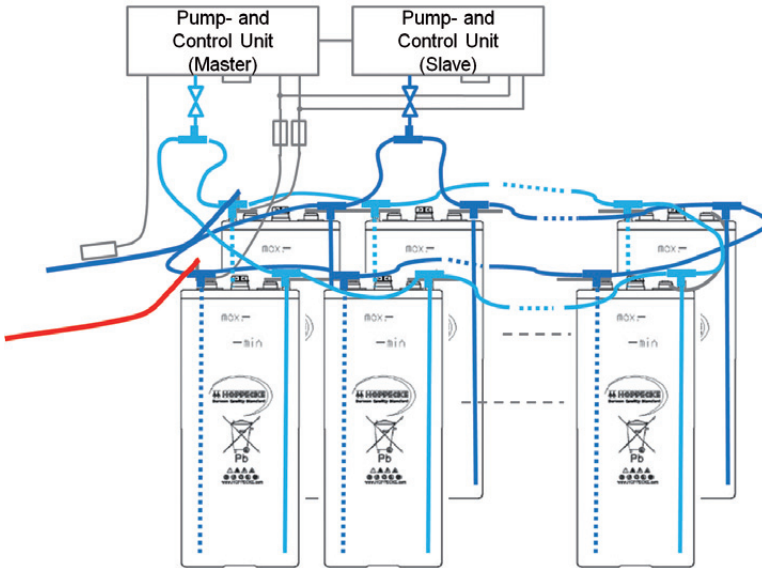

Figure 5: System setup for 48V battery systems with cells \geq 18 OPzS solar.power 3250 (18 OPzS solar.power 3250 up to 26 OPzS solar.power 4700)

Installation

The installation procedure in this section describes how to retrofit a HOPPECKE Electrolyte Circulation System in an existing battery installation. It considers the default operating mode.

Before installation:

- Check if all required components have been delivered.
- **Note:** The Electrolyte Circulation System cannot be used with a recombination system (HOPPECKE AquaGen® premium.top) simultaneously. Any recombination system plugs need to be replaced by the HOPPECKE Labyrinth plugs (refer also to /3/).
- Please contact your HOPPECKE representative in case you want to use the Electrolyte Circulation System together with an automatic water refill system.



Attention

Important note: Before starting the installation procedure make sure that all safety precautions (refer to chapter Safety precautions) are fulfilled. That includes:

1. Use insulated tools only.
2. Wear insulating rubber gloves and rubber shoes.
3. Wear protective glasses.



Important note: Ensure that all electrical loads are switched off (separators, fuses, switches). This must be carried out by qualified personnel.

Please consider that even after switching off all electrical loads metal parts of the battery are always live. Never place tools or other objects on top of the batteries.

Step 1: Equip battery cells with air tubes

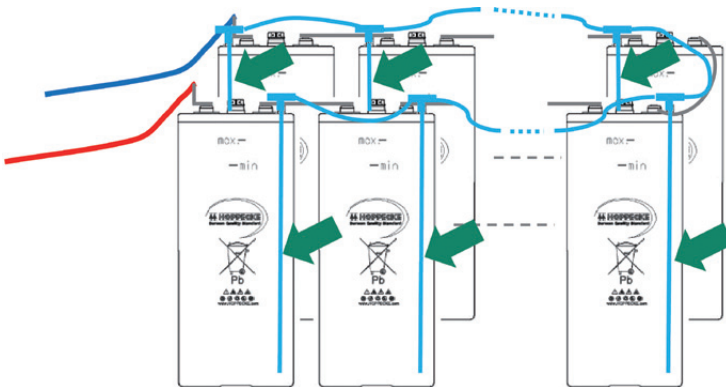

Figure 6: Inserted hard plastic tubes

1. Open the battery service holes by pulling the little green plugs which are placed on the battery cell lids (refer to Figure 7). Keep the green plugs for potential later usage.



Figure 7: Service hole

2. Insert the black rubber part into the service hole of the cell lid (refer to Figure 8).
3. Insert delivered hard plastic air tubes (one into each battery cell). Refer also to Figure 9).
Note: This tube needs to be pushed through the tiny plastic funnel located on top of an empty gauntlet of the positive tubular plate right underneath the battery service hole.
The hard plastic tube comes with a length which is compatible to the corresponding battery cell.
When finished the head of the air tube is located 1 to 2 cm beneath the end of the electrode plate sets (refer also to Figure 6).
4. Mount the plastic T-junctions on top of the hard plastic tubes.

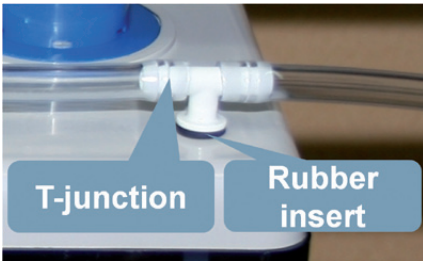

Figure 8: T-junction and rubber insert

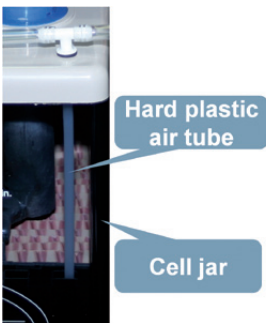

Figure 9: Hard plastic tube

Step 2: Connect all air tubes

The delivery contains a soft plastic air tube for connection between single battery cells and connection to the pump- and control unit. This air tube needs to be cut into appropriate sections with a cutter knife or scissors.

Note: The air tubes between the cells need to be as short as possible. Keep an adequate length of the air tube for connection to the pump- and control unit (check distance to the location where the pump- and control unit shall be mounted).

Put all ends of the soft air tube over the corresponding T-junctions which have been mounted on top of the hard plastic tubes (refer also to Figure 11)

Note: Make sure that all tubes are connected closely so that no air is leaking out of the system during pump operation.



Figure 10: Connection between air tubes - I

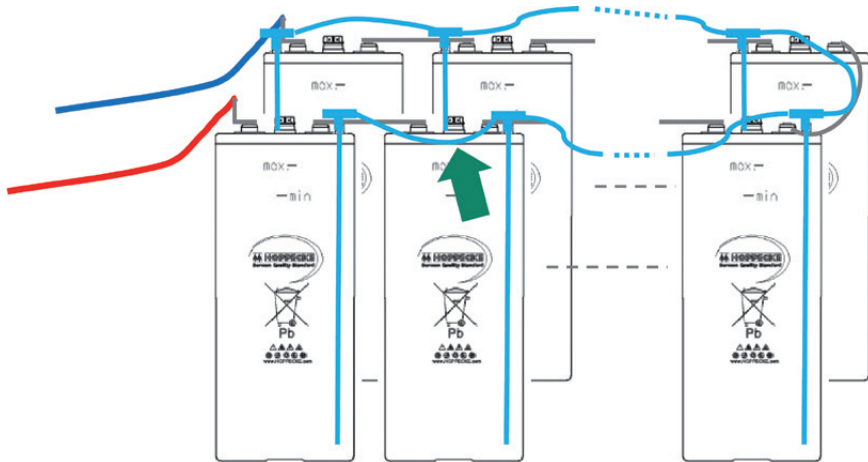

Figure 11: Connection between air tubes - II

Step 3: Mount the pump- and control unit

The pump- and control unit shall be mounted on a wall above the battery system. This avoids that under no circumstances electrolyte liquid can be pushed towards the pump system. The housing should be located close to the battery connection terminals (+/-). This is typically the end which is connected to the battery charging device (refer also to Figure 12).

Note: The maximum distance between the pump- and control unit and the battery is determined by the length of the remaining (soft) air tube, the cable length of the current sensor and the cable length of the power supply cable (refer also to Figure 4). This distance is about 3m max.

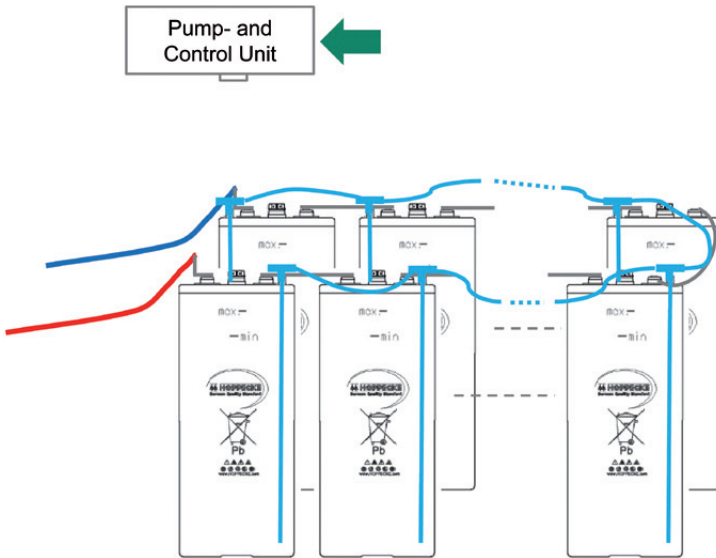

Figure 12: Installation of pump- and control unit

Step 4: Connect air tube to the pump- and control unit

Both ends of the air tube need to be connected to one T-junction. Integrate the back pressure valve with two short air tubes and connect the remaining end to the air outlet nozzle of the pump- and control unit (refer to Figure 13 and Figure 14).

Note: The installed air tubing shall realize a closed loop. Avoid open or dead ends.

Note: For 48V battery systems with larger cells (18 OPzS solar.power 3250 up to 26 OPzS solar.power 4700) two electrolyte circulation pumps are required. In that case two separate air tube loops need to be realized. Arrange the tubing in a way that each pump is connected with each cell of the battery system. One pump serves as a master and is connected to the current sensor. The master pump activates / deactivates the slave pump via a control wire (refer to Figure 5).

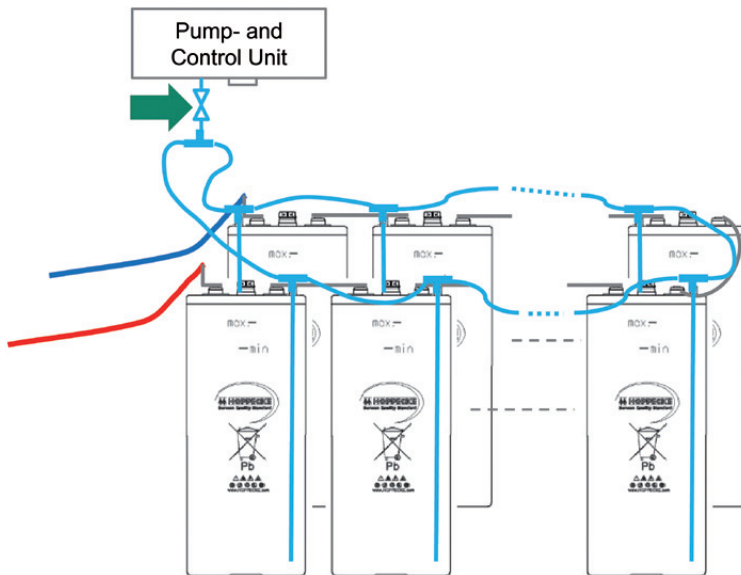

Figure 13: Connect air tubing to pump- and control unit



Figure 14: Connection of back pressure valve

Step 5: Install current sensor

The current sensor detects whether the battery is in charge or discharge mode. The pump works only during battery charging mode. The inductive sensor comes with a plastic housing. The sensor should be attached to the negative battery connection cable (refer to Figure 15). This is typically the cable which goes to the charging device. Use the provided wire straps for attachment.

Note:

- The arrow printed on the current sensor must show towards the charging device (refer to Figure 16).
- The label "This side high sensibility / sensitivity" typically faces towards the battery cable.

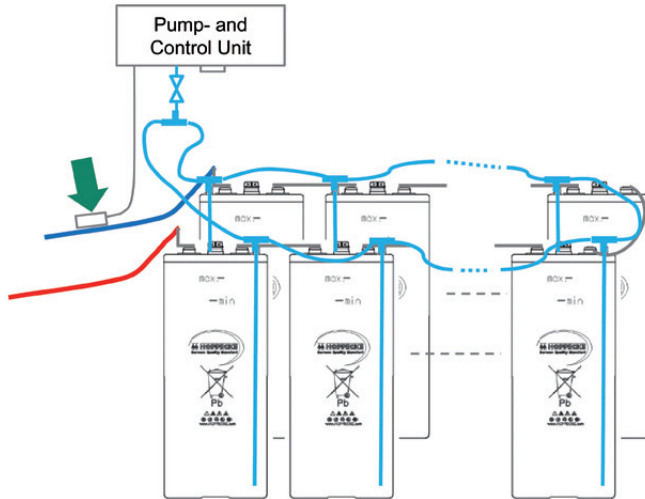

Figure 15: Attachment of the current sensor

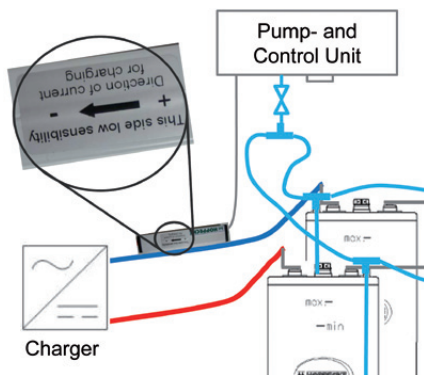

Figure 16: Arrangement of current sensor

The current sensor is equipped with a LED to indicate a detected charging current. The absolute charging current needs to be at minimum 5A to 10A to trigger the pump system (refer to Figure 17).
 Note: If the current sensor is mistakenly mounted in the wrong direction the pump will work during battery discharge. This has to be avoided.

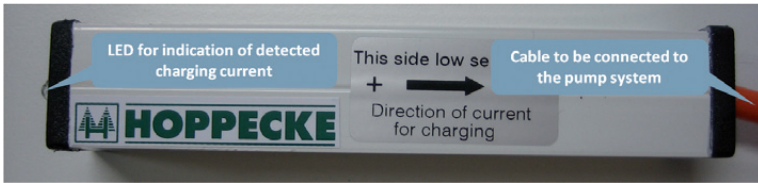

Figure 17: Current sensor

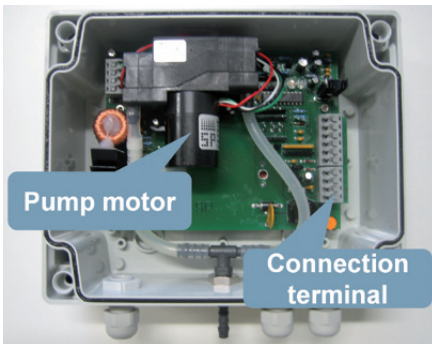

Figure 18: Connection terminal

To access the connection terminal inside the housing remove the cover by loosening the four plastic screws. Pull the cable of the current sensor through one of the cable bushings of the housing. The blue cable of the current sensor needs to be connected to the '-S' terminal and the brown cable must be connected to '+S' (refer to Figure 18 and Figure 19).

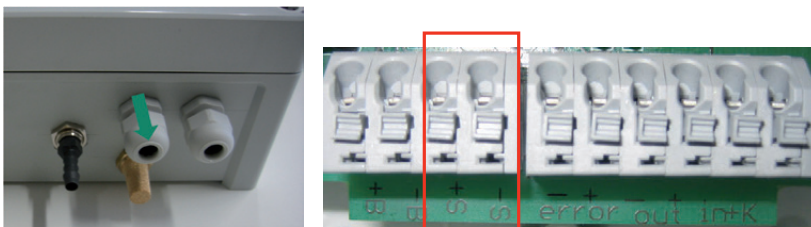

Figure 19: Connection terminal for current sensor

Step 6: Connect power supply



Attention!

Important note: Before proceeding with any step mentioned in this section disconnect all electrical loads and charging device(s) via the battery circuit breaker!

Electrical power for the pump- and control unit is supplied by the battery system. For battery service activities all loads and charger(s) need to be disconnected completely from the battery. Therefore power supply for the pump- and control unit needs to be disconnected from the battery in case of any service activities on the battery system or the pump system itself. This is done by removing the fuses from the fuse holders.

Perform the following steps for connection of the power supply:

1. Check the length of the power supply connection cable (orange, 2 x 1,5mm², type H07BQ-F) which goes into the pump- and control unit.
2. Check the remaining distance between the end of the power supply connection cable (which will be attached to the pump- and control unit) and the battery connection terminal. For this distance two cords of the provided (black, 6mm², type: H07 RN-F) connection cables are needed (refer to Figure 20 and Figure 24).
3. Mount the DIN cap rail below the pump- and control unit (refer to Figure 23).
Note: Depending on operating conditions high humidity rates DIN cap rail and fuse holders needs to be placed in an extra installation box.



Danger!

4. Clip the two fuse holders onto the DIN cap rail (refer to Figure 23).
Note: The fuses must not be inserted.
5. Pull the 1.5mm² connection leads equipped with wire termination through one of the cable bushings of the housing and attach each lead to the corresponding terminal inside the pump- and control unit (refer to Figure 21). '+B' will be connected to battery plus and '-B' to battery minus.
6. Attach the wire termination to the end of each 1.5mm² (orange) connection cable.
7. Connect the ends of both 1.5mm² (orange) connection cables to the corresponding fuse holder terminals.
8. Cut the 6mm² (black) power supply connection cable into two single cables of appropriate length.
9. Attach the wire termination to one end of each 6mm² (black) connection cable.
10. Drill a hole into each plastic cap of the provided battery terminal bolt and feed each 6mm² (black) cable through that hole. Attach a cable lug to the end of each 6mm² (black) connection cable.
11. Connect the ends with the wire termination to the corresponding fuse holder terminal.
12. Replace both existing battery terminal connection bolts (+ and -) by the provided terminal bolts (refer to Figure 22)
13. Connect the cable lugs (of both 6mm² connection cables) to the 5mm thread (M5) on top of the terminal connection bolt with the provided 5mm screws.
14. Put the provided plastic covers onto the battery terminal connection bolts for touch protection.

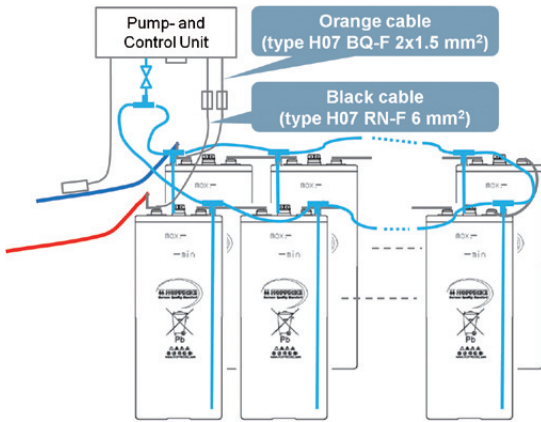

Figure 20: Power supply connection

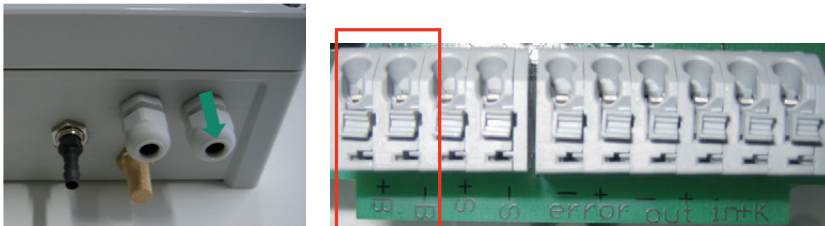

Figure 21: Connection terminal for power supply

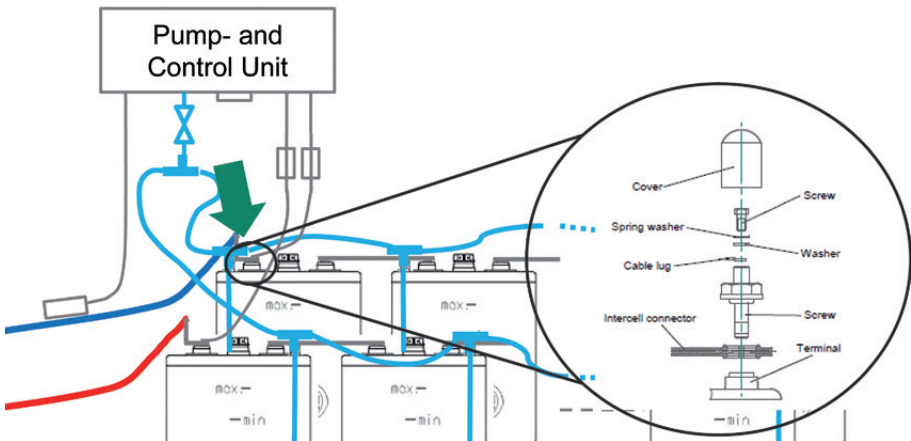

Figure 22: Power supply connection - Battery terminal connection bolt



Figure 23: DIN cap rail and fuse holders

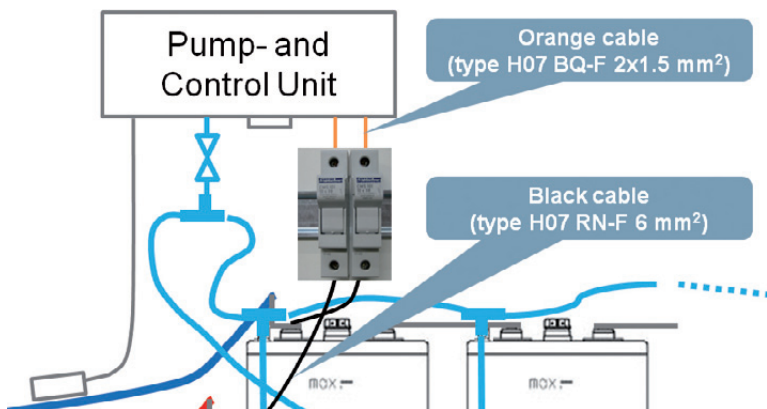

Figure 24: Fuse holder connection



Figure 25: Terminal connection bolt and plastic cover

Operation

The HOPPECKE Electrolyte Circulation System recognizes via the current sensor whether the battery is charged or discharged. Only during battery charging operation the pump control unit will switch the pump on for a certain interval. During pump operation ambient air is filtered and passed to the air outlet nozzle. The air stream is then directed via air tubes to the bottom of every single battery cell. From there emerging air bubbles rise through the electrolyte, ensuring a homogeneous electrolyte density distribution in each battery cell. The air bubbles leave the battery cell by passing the labyrinth plugs.

Note: The pump is operated automatically and does not require any manual actions.

Note: The fuses of the pump- and control unit need to be removed before removing the cover of the pump housing or starting any battery service activities (e.g. topping up demineralized water etc.).

The pump- and control unit is equipped with two LED for indication of normal operation (green) or error states (red). The LED can be seen through the round inspection window covered with clear plastic (refer to Figure 28).



Figure 28: Inspection window

LED indications:

- Green LED flashes one time means battery voltage is < 25.2V.
- Green LED flashes two times means battery voltage is < 36V.
- Green LED flashes three times means battery voltage is < 50.4V.
- Green LED flashes four times means battery voltage is > 50.4V.

After the pump- and control unit is supplied with the battery voltage the system runs a 60s self test. After that the pump is ready for regular operation. Once the current sensor detects a charging current of minimum 5A to 10A a ten minutes countdown is triggered. After that the pump works for 12min and will be switched off for approx. 48min thereafter. This interval is repeated as long the current sensor detects a charging current.

Connection terminals

To access the connection terminal the cover of the housing needs to be removed by loosening the four plastic screws.

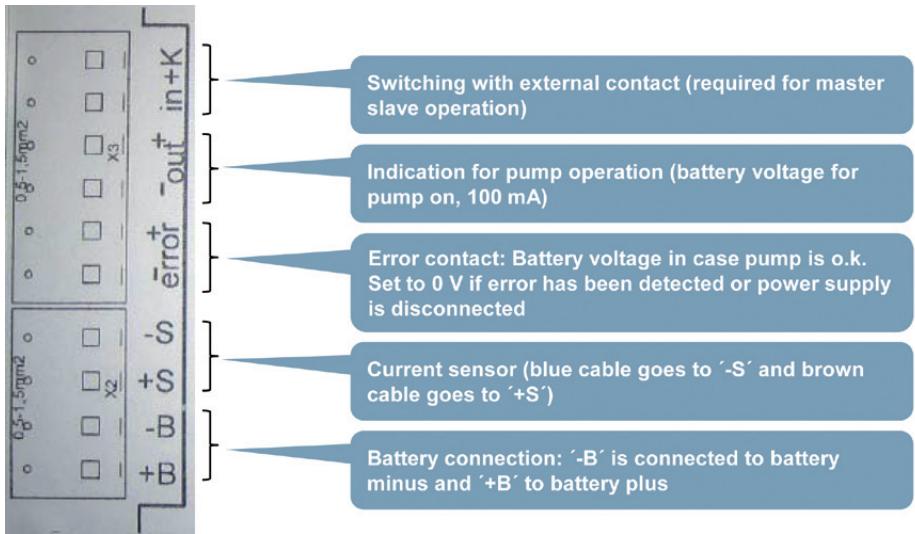

Figure 29: Connection terminal

Error states

The following error stated can be detected by the pump- and control unit (refer to Table 1):

Error	Cause	Indication	Error Correction
Pump is switched off because air pressure ist not reached.	Detached or leaking air tubes.	Pump is switched off, red LED flashes 1x.	Check tube connections and remove fuses for a few seconds an insert again.
Pump is switched off because operating temperature is > 65 °C.	E.g. pump- and control unit is exposed to direct sunlight.	Pump is switched off, red LED flashes 2x.	Pump will start again automatically once the temperature has fallen below ca. 60 °C.

Table 1: Error states

Maintenance

The pump motor and the control unit of the Electrolyte Circulation System are maintenance free. However HOPPECKE recommends replacing the air intake filter every year.

Technical Data

Technical characteristics

Battery	
Applicable Type	OPzS solar.power
Capacity Range at C100	6 OPzS solar.power 910Ah to 26 OPzS solar.power 4700Ah

Pump	
Motor	Brushless
Volumetric current	720 l/h at 100 mbar

Voltage / Current 24V DC / 48V DC (ca. 0.6A / 0.3A)

Power consumption Ca. 15W during operation / ca. 0.6W in standby
(approx. 20 Wh during 6h battery charging phase)

Housing (Pump and Control Unit)



Figure 30: Dimensions of pump- and control unit

Dimensions in mm (refer to Figure 30).

Assignment of hard plastic air tubes for insertion into battery cells (refer to Table 2):

Battery Type	Length of hard plastic tube	Material number of tube
6 OPzS solar.power 910	603 mm	7145215593
7 OPzS solar.power 1070	603 mm	7145215593
8 OPzS solar.power 1220	603 mm	7145215593
9 OPzS solar.power 1370	603 mm	7145215593
10 OPzS solar.power 1520	603 mm	7145215593
11 OPzS solar.power 1670	603 mm	7145215593
12 OPzS solar.power 1820	603 mm	7145215593
12 OPzS solar.power 2170	743 mm	7145215733
14 OPzS solar.power 2540	717 mm	7145215707
16 OPzS solar.power 2900	717 mm	7145215707
18 OPzS solar.power 3250	717 mm	7145215707
20 OPzS solar.power 3610	717 mm	7145215707
22 OPzS solar.power 3980	717 mm	7145215707
24 OPzS solar.power 4340	717 mm	7145215707
26 OPzS solar.power 4700	717 mm	7145215707

Table 2: Assignment of air tubes to battery cells

Annex A: References

The following tables contain the length of the lead electrode for various HOPPECKE battery cells.

- /1/ "Installation, commissioning and operating instructions for vented stationary lead-acid batteries", Copyright HOPPECKE Batterien GmbH & Co. KG, Mar 2009
- /2/ "OPzS solar.power Charging Procedure", Copyright HOPPECKE Batterien GmbH & Co. KG, V1.1 (Nov 26th 2010)
- /3/ Instructions for use – AquaGen® premium.top", Copyright HOPPECKE Batterien GmbH & Co. KG, 04/08



HOPPECKE

POWER FROM INNOVATION

Installation and Operating Instructions

Electrolyte Circulation System



HOPPECKE

POWER FROM INNOVATION

HOPPECKE Batterien GmbH & Co. KG

P.O. Box 1140 · D-59914 Brilon
Bontkirchener Straße 1 · D-59929 Brilon-Hoppecke

Phone +49(0)2963 61-0
Fax +49(0)2963 61-270

Email info@hoppecke.com
www.hoppecke.com