

AIR Circuit Replacement Instructions

Items included with this kit:
(see Exploded View p. 3)

ITEM	ITEM NAME	QUANTITY	
1	SCREW - SOCKET HEAD - 10-24 X 1-1/2"	4	includes 1 spare
2	O-RING	1	
3	SCREW - SOCKET HEAD - 6/32 3/16"	4	
4	GROUNDING BRUSH WITH SPRING	1	
5	SCREW - TAPTITE - 8/32 X 1"	2	
6	BRUSH SPRING	2	
7	BRUSH SPRING BASE	2	
8	AIR BREEZE OR AIR X CIRCUIT/RECTIFIER ASSY	1	
9	WIRE HARNESS WITH POTENTIOMETER	1	connected to circuit board
10	SNAP RING - 32mm EXTERNAL	1	
*	NUT - JAM - SAE - 1/4 -28	1	potentiometer nut
*	WASHER - INTERNAL STAR - 1/4"	1	potentiometer washer
*	LED CLIP	1	
*	ANTI-STATIC WRIST STRAP	1	
	* ITEMS NOT SHOWN.		

Additional items needed (not included):

ALLEN KEY - 5/16" SHORT ARM
ALLEN KEY - 5/32" SHORT ARM
FLAT HEAD SCREWDRIVER
PAIR OF EXTERNAL SNAP RING PLIERS
RUBBER OR PLASTIC Mallet
HAMMER
TORQUE WRENCH
1/4" SOCKET OR NUT DRIVER
5/16" SOCKET OR NUT DRIVER
10mm BOX-END WRENCH
NON-METALLIC LONG BLUNT OBJECT (FOR YAW SHAFT REMOVAL)
DENTAL PICK OR EQUIVALENT
BRILLO, SCOTCH-BRITE PAD, OR EMERY CLOTH
SMALL AMOUNT OF SILICONE
RAG
7/64" ALLEN KEY
PUNCH
PERMANENT MARKER
SUPER GLUE

Important notes before you begin:

PLEASE READ ALL OF THE INSTRUCTIONS BEFORE BEGINNING THE UPGRADE PROCEDURE.

Pay attention to the tightness of each bolt as you remove it in order to get a feel of how tight they need to be when the parts are reinstalled. Be careful not to over-tighten.

PERFORM ALL TESTING PROCEDURES PRIOR TO RECONNECTING TURBINE TO BATTERY SUPPLY.

Exploded View:

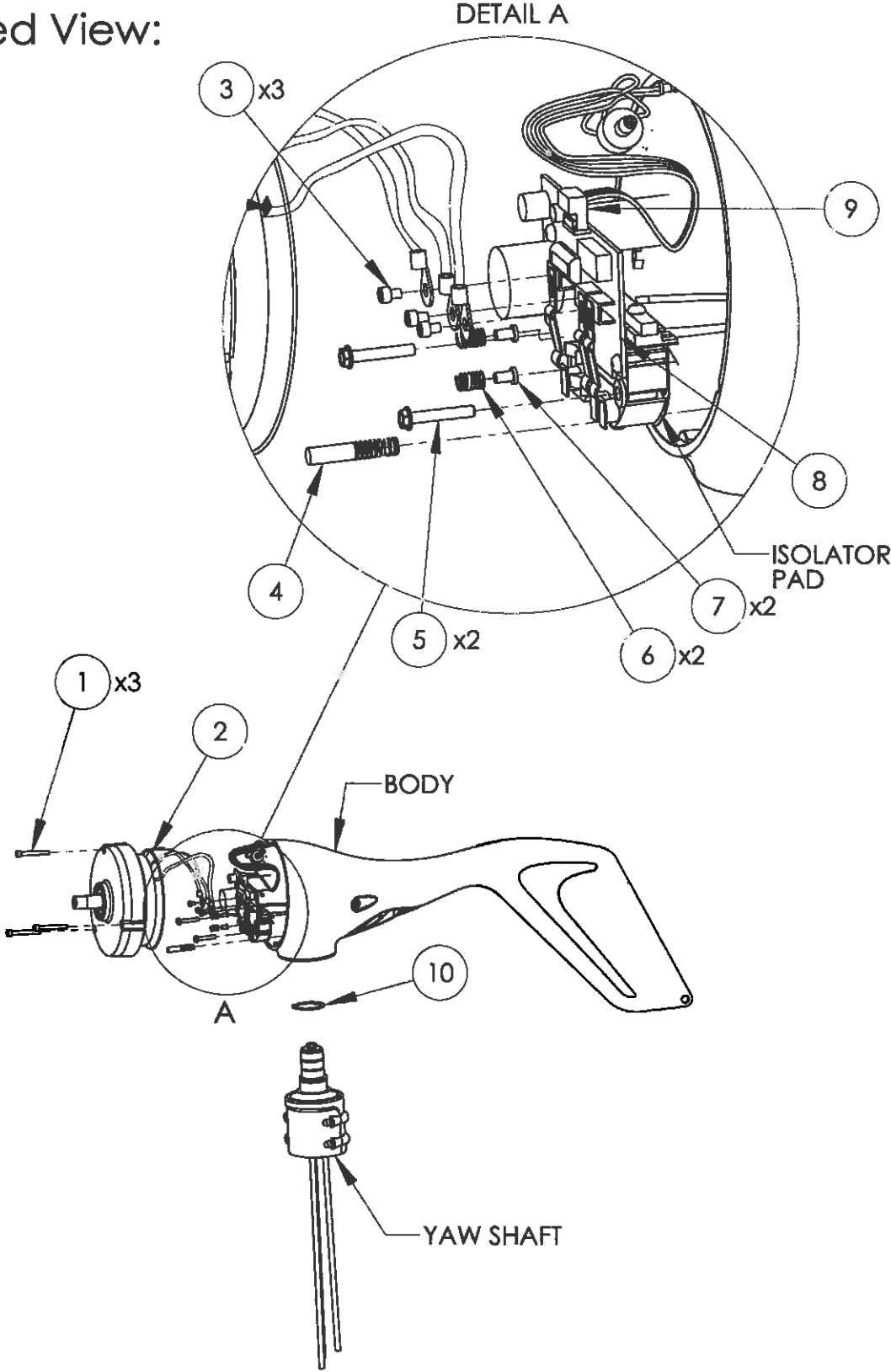

1. Disconnect the wires and remove the turbine from the mount as per the AIR X or AIR BREEZE Owner's Manual, Section 6. Remove the nose cone, then the blade assembly with a $\frac{5}{16}$ " hex key.
2. Using the $\frac{5}{32}$ " hex key, remove the three screws from the face of the turbine.
3. Remove the face by using a small flat head screwdriver to pry open the front. If it is a marine unit, be careful not to damage the powder coating. Remove and discard the old o-ring. The stator, rotor, and face should come off as a single assembly
4. If the face casting comes off and the stator remains in the body, firmly grasp the rotor shaft with one hand and the body of the unit with the other hand and pull the rotor straight out. Moderate force will be necessary to overcome the magnetic field that holds the rotor inside the stator. Use a flathead screwdriver to pry the stator from the body. This is done by inserting the blade of the screwdriver into one of the three recessed areas where the stator meets the body of the unit, and carefully prying the stator out a little bit. Work your way around the stator prying little by little at all three of the recessed points until the stator is removed.
5. Carefully note the routing of the wires connecting the stator windings to the circuit board. Note the parallel orientation of the three stator ring-terminals and how they are isolated from one another. Also, take note of the circuit and the way it is positioned inside the body. Note how the yaw shaft is seated in the bearing and how the brushes make contact with the slip rings behind the yaw shaft. Take note of the Exploded View at the beginning of this document for part identification.
6. Attach the anti-static strap to your wrist per the instructions on the strap package.
7. Using a $\frac{7}{64}$ " allen key, remove the three small screws connecting the stator wires to the circuit. NOTE: (It is very easy to strip the threads on these screws when reattaching the stator wires. Try to get a feel for the factory torque setting (10 in-lbs) on these bolts. They will need to be reattached in the same manner.)
8. It is possible to use two methods to remove the circuit:

METHOD #1

- a.) Using the external snap ring pliers, remove the snap ring from its groove located below the slip rings on the yaw shaft assembly. A screwdriver may assist in the removal of the snap ring. See Fig. 1



Fig.1

- b.) Once the snap ring is removed, use a hammer and a blunt object or a plastic mallet to drive the yaw shaft assembly out by hitting it on the top end of the slip ring assembly, or use a screwdriver to separate the yaw shaft assembly from the body. This may take a little effort; so be careful. As the yaw assembly is removed, watch closely for the earth-ground brush and spring as they may release and be difficult to find. See Fig. 2

VERY IMPORTANT: If the yaw shaft requires more than moderate force to remove, or if there is concern for the well-being of the balance of components due to the force that is necessary to remove the yaw shaft, try using method #2. DO NOT attempt to force the yaw shaft out of the body. Damage to the body, yaw shaft, or both may result. Contact Southwest Windpower (928-779-9463) or nearest representative for advice on how to proceed or for alternate solutions to the replacement of the circuit. You may be asked to return the unit to the factory for repair.

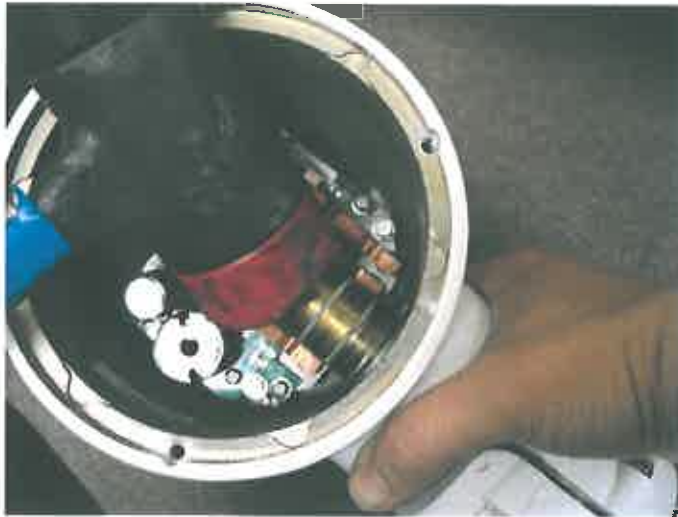

Fig. 2

- c.) With the yaw shaft assembly removed, use a 1/4" socket or nut driver to remove the two screws holding the circuit to the body casting. These are the screws on the left and right side of the solid metal rectifier (item 13 on exploded view).

METHOD #2

Important note: snap ring must remain in place for this method. If you removed it in attempt to use method #1, replace it now.

- a.) Remove the bolt, washers, and fiberglass spacer from the top of the slip ring assembly using a 10mm box-end wrench. See Fig.3 **NOTE: New circuit boards will have this large capacitor on the opposite side shown.**



Fig.3

- b.) Pull the slip ring assembly out of the body, which will give room to remove and replace the circuit. It is not necessary to pull the wires completely through the yaw shaft, but care must be taken not to damage the insulation on the wires during the upgrade process.
 - c.) With the slip ring assembly removed, use a 1/4" socket or nut driver to remove the two screws holding the circuit to the body casting. These are the screws on the left and right side of the solid metal rectifier (item 13 on exploded view).
9. Carefully remove the circuit from the body as it is still connected by ribbon cable to the potentiometer and LED light. See Fig. 4

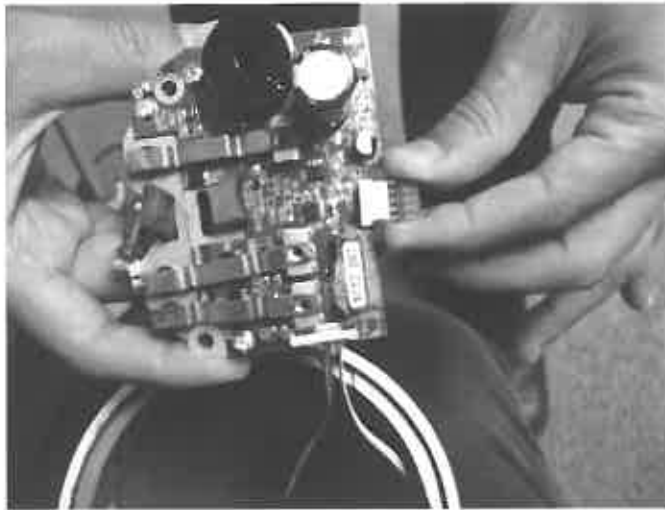

Fig. 4

10. Unclip the ribbon cable from the circuit. See Fig. 4
11. Use a 5/16" socket or nut driver to remove the potentiometer nut on the side of the unit. (The socket or nut driver may need to be modified by grinding or filing it to make a thinner wall of material on the tool. This will allow it to fit into the body contour to remove the nut.)
12. Gently push the potentiometer from the unit. The potentiometer should give way very easily. Clean the excess silicone off of the turbine.
13. Lightly tap the LED with end of the screwdriver handle to push it into the body. Tap only on the LED and not on the black clip holding it. The LED should give way very easily. Pull out the old black LED clip. Clean the excess silicone off of the turbine.
14. Turn the body open-side down and shake it to remove any debris. If you used method #2 to remove the circuit, hold the slip ring assembly to avoid damage to the wire insulation.
15. Thoroughly clean the flat surface on the body where the circuit is mounted. It is very important that the contact area between the circuit and body be free from debris. Any miscellaneous metal particles in this area could short-circuit the turbine and cause a malfunction. Also, clean the top of the yaw bearing if grease is present.
16. Carefully unpack and examine the new circuit. Check that the small, insulating plastic tubes are in place within the screw holes which attach the board to the body casting. If any pieces are missing from the circuit or the bolt packages, please contact the factory. Be very careful with the rectifier insulator pad on the new circuit. Check to make sure the pad is not cut or damaged. The pad must electrically insulate the rectifier from the body in order for the turbine to work properly. Any damage to the pad that allows an electrical contact between the rectifier and the body will cause the turbine to malfunction.
17. The new circuit will have a wire harness/potentiometer already connected. Should you need to reconnect it for any reason, be aware that the clip has a polarity that is important to observe. The correct connection orientation is shown in Fig. 5 below. Each circuit is supplied with its own wire harness - the wire harness must only be used with the circuit it is supplied with.

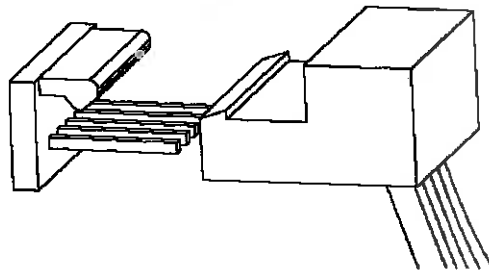

Fig. 5

18. Place the new AIR X or AIR BREEZE circuit next to the front of the body. Holding the ribbon cable, carefully separate the two LED wires, as a pair, from the potentiometer wires. Leave about 7" of ribbon cable intact (in the five wide form) from the circuit. See Fig. 6

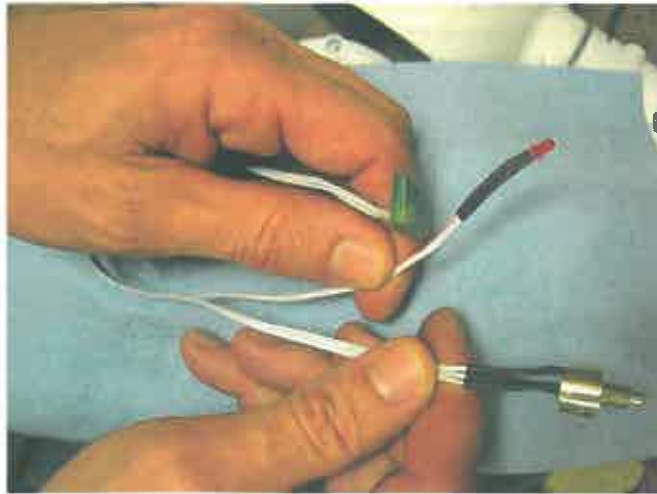

Fig. 6

19. Straighten out the wires that lead to the LED by running it between your thumb and index finger. Gently squeeze the wires near the LED together to allow it to properly fit into the LED clip. Do not attach the clip yet.
20. Hold the empty body with the yaw shaft on top, and gently run the LED wire down the body. Push the LED through the LED hole.
21. Push the new black LED clip onto the LED until you feel it snap lightly into place. The tip of the LED should stand approximately 1/8" above the clip. Place 1 drop of super glue on the LED and clip.
22. Gently pull the wire from the inside of the unit while guiding the LED with clip towards the hole.
23. Gently press the LED clip down until the assembly slides into the hole. None of the four tabs should catch on the edge of the hole. Use a dental pick or equivalent to press down the LED CLIP flush into the unit. DO NOT push down directly on the LED. The LED clip should be flush with the body and the LED should stick out 1/8" above the clip. See Fig. 7



Fig. 7

24. Place 2 drops of super glue on the edges of the LED clip so that the glue can run down into the gap around the clip.
25. Remove any excess super glue from the body, being careful not to push the LED into the body.
26. Next, install the potentiometer. Place a bead of silicone on the surface that will mate to the body casting. Insert the potentiometer into the hole on the side of the unit and place the star washer and the nut loosely over the threads. Orient the entire potentiometer so that the slot on the top of the shaft aligns with the dimple on the body, to mark the

default setting for the internal regulator. See Fig. 8. (The new circuit and potentiometer are preset to the factory voltage setpoint. For instructions on adjusting the potentiometer to change the regulation voltage, see section 7-3 in your AIR BREEZE owner's manual or section 4.4 in your AIR X owner's manual.) Holding the potentiometer only from the inside, being careful not to hold onto the potentiometer wires, tighten the nut until the potentiometer is snug. If it is not possible to keep the slot aligned with the dimple or if a dimple does not exist, make a new dimple (using a punch) and orient the slot as described above and mark it with a permanent marker. Be careful that the potentiometer wires do not interfere with the LED wires and make sure that the LED does not pull out of the clip when you tighten the potentiometer. Be careful not to crush the LED wires or potentiometer wires between the body casting and the potentiometer.

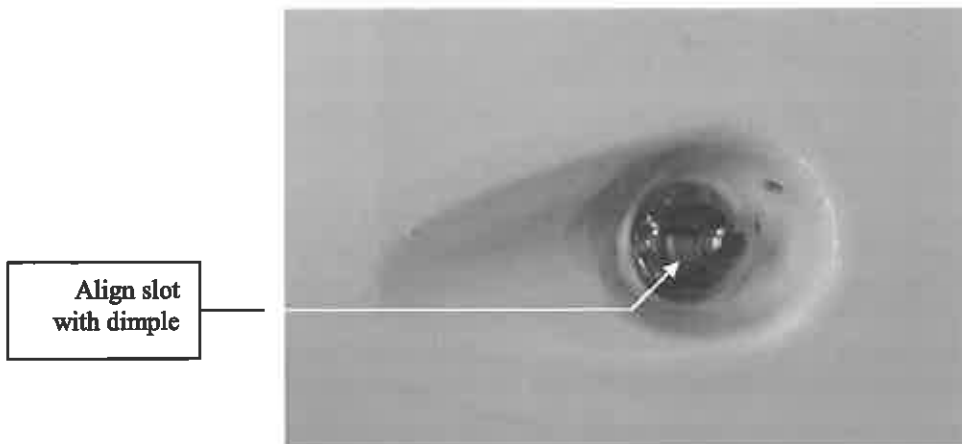

Fig. 8

27. Place the circuit in position in the body aligning the two mounting screw holes. Ensure that the insulator pad adheres to the rectifier and is not peeled or bent away from the rectifier. While orienting the circuit in the turbine, try to tuck the ribbon cable down towards the tail of the body to prevent it from being pinched as the circuit is bolted down. See Fig. 9 below for correct orientation.

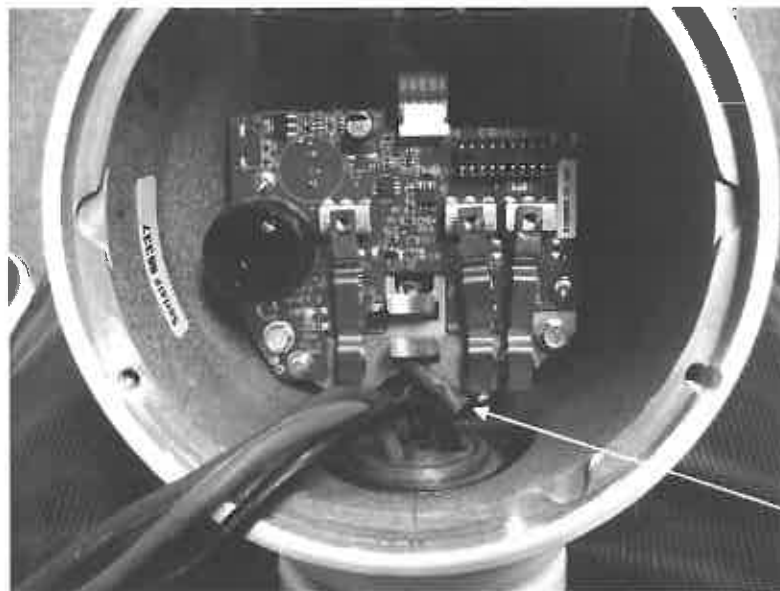

Fig.9

28. Tighten the two screws so they snugly secure the circuit to the body, approximately $\frac{1}{4}$ turn once seated... DO NOT over-tighten the screws as the white plastic insulators may distort and cause future malfunction.
29. Ensure that the ring terminal at the attachment point of the red brush wire attached to the bottom of the metal rectifier assembly does not touch the body. This will connect battery positive to the turbine case, will short-circuit the turbine, and cause a malfunction. See Fig 9.
30. At this point it is advantageous to stand the body on end with the body opening pointing straight up. Sit in a firm chair and hold the body between your knees with the tail resting on the floor.
31. Lift the two brushes from the two slots on the rectifier using the dental pick or equivalent tool... Insert a plastic spring standoff and then a spring in each of the two slots. Place the brushes on top of the springs and then push up and

down to make sure the springs and brushes are working together. Check that the spring remains vertical and is not sliding out of the rectifier slot.

32. Make sure the bottom brush wire is between the rectifier and the circular ground sleeve on the body casting. A small screwdriver may be necessary to push this wire into its proper position. Be sure that the brush moves freely inside the slot. See Fig 10.



Fig. 10

33. Insert the ground brush and spring into the circular ground sleeve on the body casting. Be sure that the spring side is inside the hole and the solid brush is extending from the hole.
34. If you used method #1 to replace the circuit, clean any debris from the yaw shaft bearing seat.
35. Regardless of which method you used to replace the circuit, inspect the slip ring assembly for tightness, alignment, or unusual wear. Clean any grease or oxidation off of the slip rings on the yaw shaft with abrasives such as: Scotch bright, a Brillo pad or a piece of Emery cloth. Wipe the slip rings with a clean rag. The slip rings should not be buffed to a shine, but clean with the fine scratches from the abrasives. This procedure will improve the electrical contact and promote the "seating" of the brushes and the yaw shaft.
36. Ensure that each brush properly operates in its brush holder prior to re-inserting the yaw shaft or replacing the slip ring assembly.
37. It is possible at this point to perform a continuity test to ensure that the rectifier pad was not damaged when the new circuit was installed: there should be no continuity between the positive brush and the body casting, or the negative brush and the body casting.
38. If you used method #1 to replace the circuit, partially insert the yaw shaft assembly into the bearing hole. Place the external snap ring just over the slip rings of the yaw shaft prior to setting the brushes. While holding each brush in its respective guide, insert the yaw shaft into the hole the rest of the way. See Fig. 11. Secure one brush at a time as the yaw shaft is inserted. A rubber mallet may be necessary to tap the yaw shaft in place once all of the brushes are completely seated. Repeat the same operation with each brush until the yaw shaft is fully seated. Use caution with the brushes, they are brittle and may break with too much force applied. Ensure that the gaps between the slip rings do not "grab" the brushes while the yaw is being installed.

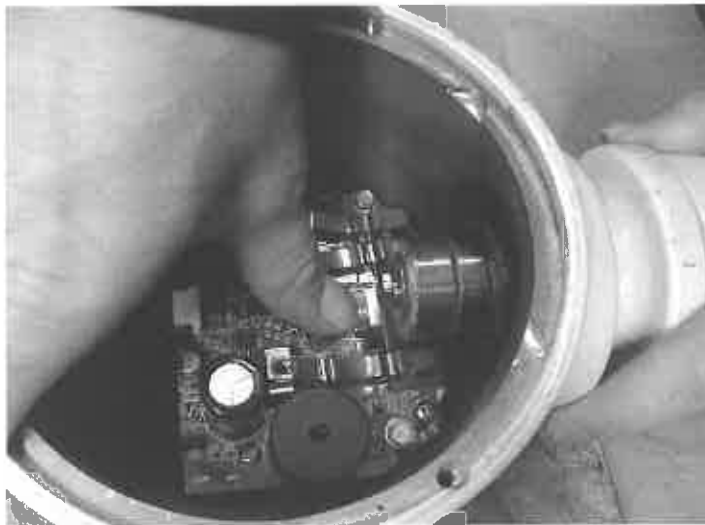

Fig. 11

39. If you used method #2 to replace the circuit, push the slip ring assembly back into its proper position on the yaw shaft while keeping the brushes depressed in their slots behind the assembly. A small pick can assist with this. Make sure the plastic insulating tube remains in the center of the slip ring assembly and that none of the wires get pinched between the slip rings - failure to do so may result in a short and malfunction. Replace the bolt with washers back into the top of the slip ring assembly making sure the fiberglass spacer is in contact with the top slip ring. Tighten bolt to approximately 75-80 in-lbs. See Fig. 12

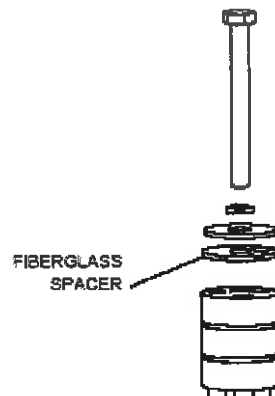

Fig. 12

40. Rotate the yaw shaft. Take a close look at each of the brushes to make sure they are properly contacting the appropriate slip ring. Make sure each spring is properly seated in the rectifier slot and that the brush wires are not being pinched. There will be fresh "brush tracks" on the slip rings. See Fig. 13. Also, make sure the slip rings are vertically aligned.
41. If you used method #1 to replace the circuit, use the snap ring pliers to place the snap ring into the groove on the yaw shaft. Make certain the yaw shaft is fully seated in the yaw bearing and the external snap ring is fully seated in its groove.
42. Check the magnets on the rotor in the new alternator assembly to make sure there is no metal stuck to the magnets. Any metal debris inside the turbine could cause the turbine to short-circuit and malfunction.
43. Orient the body as described in step 30. Using the three, small socket-head screws, connect the wires from the new alternator assembly in the following order from left to right on the circuit board: #2 - Left Terminal, #3 - Center Terminal, #1 - Right Terminal. Divert wires #3 & #1 around the PIC Chip. Do Not run the wires over the PIC Chip, this can cause malfunction. See Fig. 13 below for clarity. It is important that the three ring terminals are parallel and cannot contact one another once tightened. Torque spec for these bolts is 10 in-lbs.

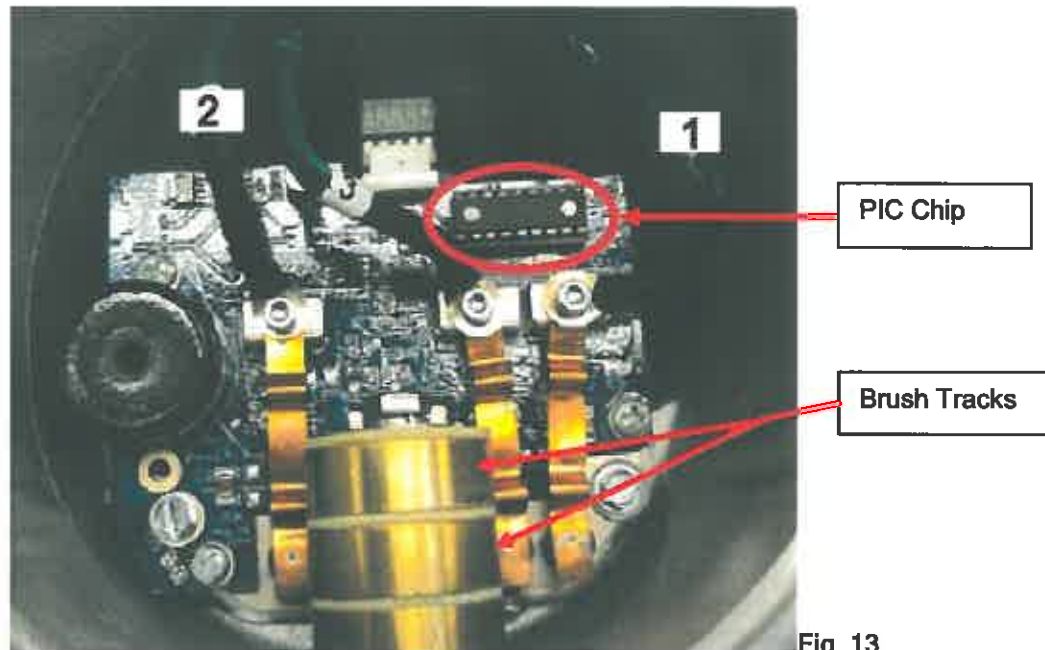

Fig. 13

44. Carefully snug each of the three stator wire mounting screws ensuring that the connectors maintain the correct alignment. **DO NOT over-tighten these screws as the threads are easy to strip.** Tighten the screws to the point where a light push in either direction on the ring terminal does not rotate the screw or ring terminal (approximately 10 in-lbs of torque).
45. Spin the rotor by hand to check for a short-circuit. If the rotor does not spin smoothly (cogs), then the circuit is either improperly installed or the circuit is defective. In the case where the turbine does not spin smoothly (cogs), check the stator wires and the rectifier plate for any indication of a short. In order to understand the difference between spinning smoothly and cogging, it is best to perform a cog test. Perform step 1 from the TESTING section toward the end of this document.
46. Push the three stator wires into the body at the 12 o'clock position (when the yaw shaft is toward you) so they will not interfere with the circuit, yaw shaft, or rotor. See Fig. 14



Fig. 14

47. Assemble the AIR BREEZE or AIR X alternator assembly to the body. Loosely place the alternator on the body opening in such a manner that the wire bundle of the stator is oriented toward the top of the body casting. Slowly re-orient the alternator assembly to align the alternator mounting bolt holes of the face with the mounting holes in the body. Be sensitive to "grabbing" of the alternator assembly during this step. Grabbing may indicate the stator wires are interfering with the circuit. **Wound stator wires must not make contact with the body casting.**
48. Loosely thread in the face bolts. Place the black O-ring around the perimeter of the AIR BREEZE or AIR X alternator assembly and loosely fit it into to the gap between the face and body castings.
49. Spin-test the rotor shaft again, to ensure that the resistance to rotation is the same as it was during the open face test in step 45.
50. Once the O-ring is in place tighten the 3 face bolts (approximately 35 in-lbs of torque)

51. Re-mount the blades to the blade hub as described in your AIR X or AIR BREEZE owner's manual. Tighten the screws to 10 ft-lbs (13.6 Nm). Note: Nylock nuts may only be used one time; replace after each use.
52. **Important note: AIR X and AIR BREEZE blades must not be used interchangeably as future replacement blades, as they are specifically designed to work with the circuitry of each turbine.** If the turbine is to be installed on a "tilt-up" tower mount the blade/hub assembly to the turbine now. Slide the hub onto the shaft. Start the 5/8-18 hub nut on the shaft threads and "spin" the hub completely onto the turbine alternator shaft. Fully tighten the hub to 50 ft-lbs (68 Nm) by inserting a 5/16 inch hex key wrench in the turbine alternator shaft and turning the shaft while turning the blades in the opposite direction.
53. If the turbine is to be installed after the tower is erected, it will be safer and easier to first install the turbine body on the tower and then install the hub/blade assembly. This will avoid attempting to mount the turbine while the blades are spinning - a dangerous condition.
54. Snap the nose cone into position over the outside edges of the blade hub. Make sure all three edges of the nose cone snap over the edge of the blade hub. After installation tug on the nosecone to make sure it is securely attached.

TESTING: To test the turbine, do the following:

- 1) Spin the shaft by hand so that it is spinning very fast. Periodically touch the black and red yaw wire together while spinning the rotor for a sample of the regulation resistance.
 - a. There should be resistance to rotation while spinning the rotor when the black and red wires are contacting one another.
 - b. There should be very little resistance to rotation while spinning the rotor with the black and red wires disconnected.
 - c. If there is cogging, or braking resistance while spinning the rotor with the wires disconnected, then there is a short-circuit in the unit. In this case, remove the face and attempt to locate the short.
- 2) Connect the red and black turbine wires to the positive and negative of the battery terminals or an adjustable voltage supply. Immediately upon making the battery connection, the AIR X / AIR BREEZE LED light should blink two times.
 - a. During these two blinks, the AIR X / AIR BREEZE applies the internal electrical brake, and the rotor should be extremely hard to rotate. After the two blinks, the rotor should again spin freely.
 - b. If the LED does not blink when the turbine is connected to a battery or power supply, the circuit is defective or there is an internal open-circuit.
 - c. If the rotor shaft spins freely during the first two LED blinks, the circuit is defective. If the circuit does not spin freely after the first two blinks, the circuit is defective or there is an internal short-circuit.